

PSSu H m F DP ETH SD

Control system PSSuniversal multi

pilz

This document is the original document.

All rights to this documentation are reserved by Pilz GmbH & Co. KG. Copies may be made for internal purposes. Suggestions and comments for improving this documentation will be gratefully received.

Pilz®, PIT®, PMI®, PNOZ®, Primo®, PSEN®, PSS®, PVIS®, SafetyBUS p®, SafetyEYE®, SafetyNET p®, the spirit of safety® are registered and protected trademarks of Pilz GmbH & Co. KG in some countries.



SD means Secure Digital

| | | |
|------------------|---|-----------|
| Section 1 | Introduction | 5 |
| | 1.1 Validity of the documentation | 5 |
| | 1.1.1 Retaining the documentation | 5 |
| | 1.2 Definition of symbols | 5 |
| Section 2 | Overview | 7 |
| | 2.1 Module features | 7 |
| | 2.2 Front view | 7 |
| Section 3 | Safety | 9 |
| | 3.1 Intended use | 9 |
| | 3.2 Safety regulations | 9 |
| | 3.2.1 Use of qualified personnel | 9 |
| | 3.2.2 Warranty and liability | 9 |
| | 3.2.3 Disposal | 10 |
| Section 4 | Function description | 11 |
| | 4.1 Block diagram | 11 |
| | 4.2 Control system | 11 |
| | 4.3 Supply voltage | 11 |
| | 4.3.1 Function description | 11 |
| | 4.3.2 Current load capacity | 12 |
| | 4.4 Integrated protection mechanisms | 12 |
| | 4.5 SD card | 13 |
| | 4.6 Reset button | 13 |
| | 4.7 PROFIBUS DP | 14 |
| | 4.7.1 Connection to PROFIBUS DP | 14 |
| | 4.7.2 Selector switch for setting the station address | 14 |
| | 4.8 Ethernet Interface | 14 |
| | 4.8.1 RJ45 interfaces ("Ethernet") | 14 |
| | 4.8.2 RJ45 connection cable | 15 |
| Section 5 | Installation | 16 |
| | 5.1 General installation guidelines | 16 |
| | 5.2 Dimensions | 16 |
| | 5.3 Installing the head module | 16 |
| Section 6 | Interfaces | 18 |
| | 6.1 Interface configuration | 18 |
| | 6.1.1 PROFIBUS DP | 18 |
| | 6.1.2 Ethernet | 18 |
| Section 7 | Wiring | 20 |
| | 7.1 General wiring guidelines | 20 |
| | 7.2 Terminal configuration | 20 |
| | 7.3 Connecting the module | 21 |

| | | |
|-------------------|--------------------------------|-----------|
| Section 8 | Operation | 22 |
| | 8.1 Messages | 22 |
| | 8.2 Display elements | 22 |
| | 8.2.1 MBUS | 23 |
| | 8.2.2 SD CARD | 24 |
| | 8.2.3 FS RUN | 25 |
| | 8.2.4 DIAG | 26 |
| | 8.2.5 FS FORCE | 27 |
| | 8.2.6 SF, BF | 28 |
| | 8.2.7 5V, 24V | 28 |
| | 8.2.8 X3: LNK, X3: TRF | 29 |
| Section 9 | Technical details | 30 |
| | 9.1 Safety characteristic data | 33 |
| Section 10 | Order reference | 34 |
| | 10.1 Product | 34 |
| | 10.2 Accessories | 34 |

1 Introduction

1.1 Validity of the documentation

This documentation is valid for the product type PSSu H m F DP ETH SD. It is valid until new documentation is published.

Please also refer to the following documents:

- ▶ PSS4000 System Description
- ▶ PSSuniversal Installation Manual

This operating manual explains the function and operation, describes the installation and provides guidelines on how to connect the product.

1.1.1 Retaining the documentation

This documentation is intended for instruction and should be retained for future reference.

1.2 Definition of symbols

Information that is particularly important is identified as follows:



DANGER!

This warning must be heeded! It warns of a hazardous situation that poses an immediate threat of serious injury and death and indicates preventive measures that can be taken.



WARNING!

This warning must be heeded! It warns of a hazardous situation that could lead to serious injury and death and indicates preventive measures that can be taken.



CAUTION!

This refers to a hazard that can lead to a less serious or minor injury plus material damage, and also provides information on preventive measures that can be taken.

**NOTICE**

This describes a situation in which the product or devices could be damaged and also provides information on preventive measures that can be taken. It also highlights areas within the text that are of particular importance.

**INFORMATION**

This gives advice on applications and provides information on special features.

2 Overview

2.1 Module features

The head module belongs to the performance class "Control system PSSu multi". The head module has the following features:

- ▶ Ethernet interface for
 - Project download
 - Read the diagnostic data
- ▶ PROFIBUS DP interface
- ▶ an FS resource
- ▶ SD card used to store the device project and the naming data
- ▶ Reset button
 - For warm reset
 - To transfer the naming data and/or device project from the SD card to the device memory
- ▶ Supply voltage
 - Integrated supply voltage for periphery supply and module supply
 - Module supply is buffered for 20 ms if the supply voltage is interrupted
 - Plug-in connection terminals (either spring-loaded terminal or screw terminal)
- ▶ Status LEDs
- ▶ Supports FS and ST modules

2.2 Front view

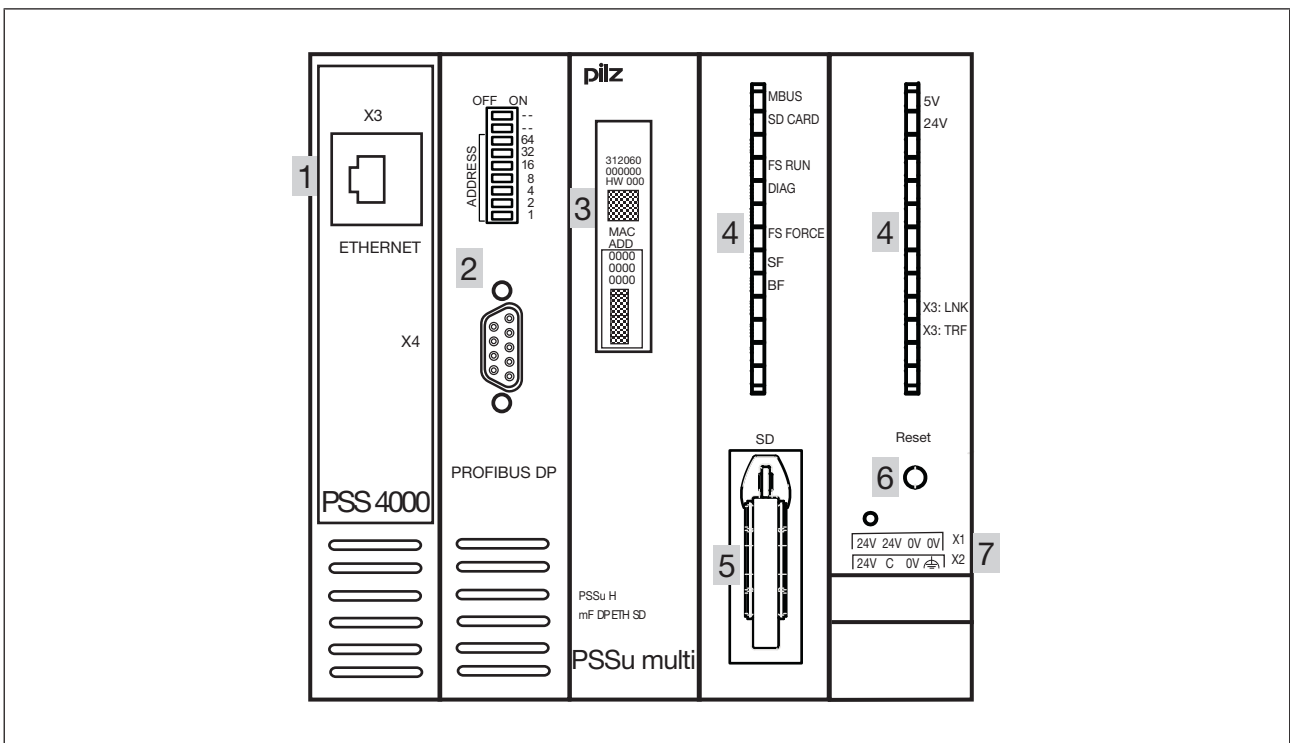

Key:

- ▶ 1: ETHERNET interface
- ▶ 2: PROFIBUS DP interface
- ▶ 3: Labelling strip (see below for details)
- ▶ 4: Status LEDs
- ▶ 5: SD card
- ▶ 6: Reset button
- ▶ 7: Supply voltage connection (module and periphery supply)

The labelling strip contains the following information:

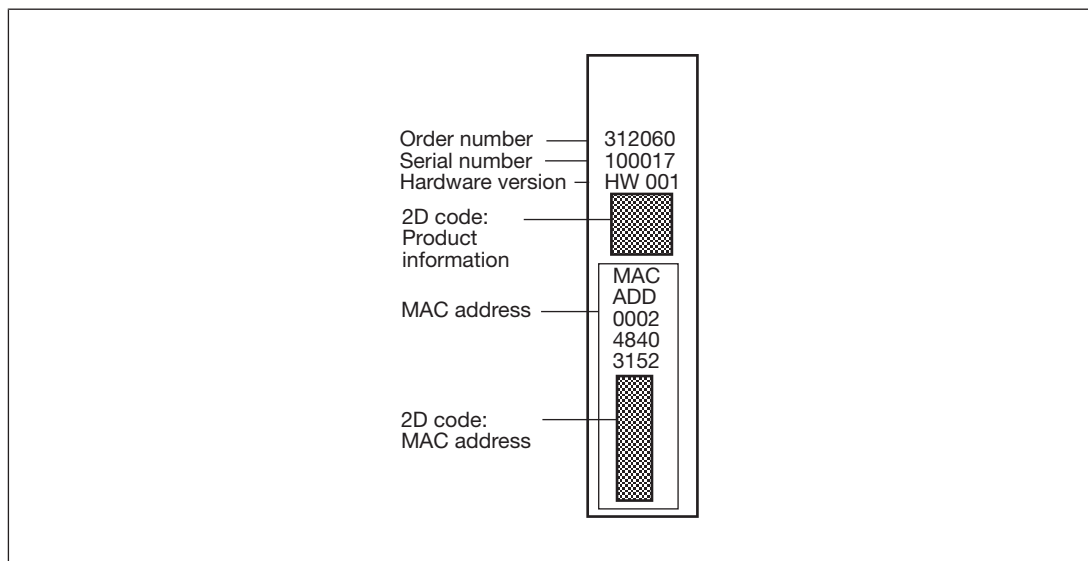

3 Safety

3.1 Intended use

The module is designed for use in:

- ▶ Safety-related applications with
 - PROFIBUS DP with local enable principle
- ▶ Non-safety-related applications with
 - PROFIBUS DP

Intended use includes making the electrical installation EMC-compliant. Please refer to the guidelines stated in the "PSSuniversal Installation Manual". The module is designed for use in an industrial environment. It is not suitable for use in a domestic environment, as this can lead to interference.

The following is deemed improper use in particular:

- ▶ Any component, technical or electrical modification to the module
- ▶ Use of the module outside the areas described in this manual
- ▶ Any use of the module that is not in accordance with the technical details.



INFORMATION

The module is supported by PAS4000 from Version 1.5.0. We recommend that you always use the latest version (download from www.pilz.de).

3.2 Safety regulations

3.2.1 Use of qualified personnel

The products may only be assembled, installed, programmed, commissioned, operated, maintained and decommissioned by competent persons.

A competent person is someone who, because of their training, experience and current professional activity, has the specialist knowledge required to test, assess and operate the work equipment, devices, systems, plant and machinery in accordance with the general standards and guidelines for safety technology.

It is the company's responsibility only to employ personnel who:

- ▶ Are familiar with the basic regulations concerning health and safety / accident prevention
- ▶ Have read and understood the information provided in this description under "Safety"
- ▶ And have a good knowledge of the generic and specialist standards applicable to the specific application.

3.2.2 Warranty and liability

All claims to warranty and liability will be rendered invalid if

- ▶ The product was used contrary to the purpose for which it is intended
- ▶ Damage can be attributed to not having followed the guidelines in the manual

- ▶ Operating personnel are not suitably qualified
- ▶ Any type of modification has been made (e.g. exchanging components on the PCB boards, soldering work etc.).

3.2.3

Disposal

- ▶ In safety-related applications, please comply with the mission time T_M in the safety-related characteristic data.
- ▶ When decommissioning, please comply with local regulations regarding the disposal of electronic devices (e.g. Electrical and Electronic Equipment Act).

4 Function description

4.1 Block diagram

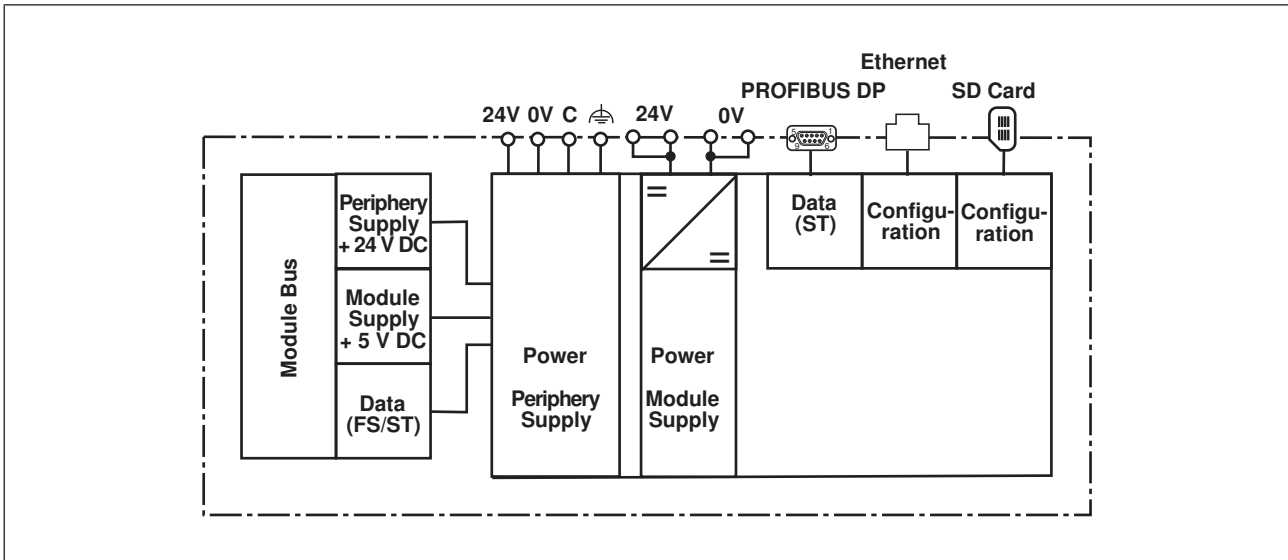

4.2 Control system

The head module is a programmable logic controller (PLC), which can be used in safety-related and non-safety-related applications. The control system has memory areas for the operating system, the data and the device project with the user program.

User programs can be created in Multi programming.

For safety-related applications, the processor section is designed with multi-channel diversity.

The control system communicates with the input and output modules via the local module bus.

LEDs provide information on the status of the control system and indicate any errors.

4.3 Supply voltage

4.3.1 Function description

The product provides the module supply and periphery supply for the modules on the module bus:

- ▶ Module supply
Supply voltage for subsequent module (right-hand side)
- ▶ Periphery supply
Supply voltage for sensors, actuators and test pulses

When the supply voltage is fed in separately, the module supply and periphery supply are galvanically isolated. If galvanic isolation is not required, a common power supply may be used for the periphery supply and module supply.

4.3.2 Current load capacity

Ensure you comply with the current load capacity of the module and periphery supply (see "Technical Details"). If the current load is higher, an additional supply voltage module is required to refresh the module supply and periphery supply.

▶ **Module supply**

The current load is the total current consumption of all the electronic and compact modules.

The module supply does not automatically switch off if values exceed or drop below their limits. However, the "5 V" LED will light and a message will be entered in the diagnostic list.

▶ **Periphery supply**

The current load is the total current consumption of the sensors, actuators and test pulses supplied via the input/output modules.

The periphery supply does not automatically switch off if values exceed or drop below their limits. However, the "24 V" LED will light and a message will be entered in the diagnostic list.

Please refer to the derating diagram.

Derating diagram for periphery supply: Temperature T dependent on load current I

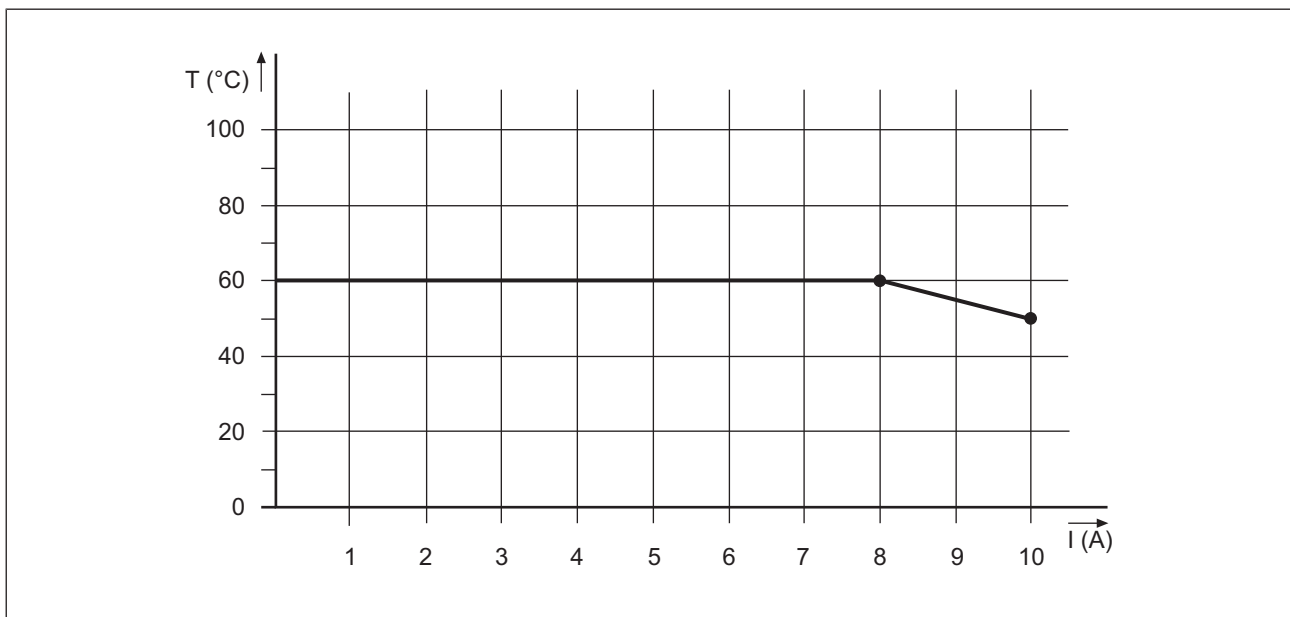

4.4 Integrated protection mechanisms

The module has the following protection mechanisms:

- ▶ Multi-channel diverse processor section
- ▶ Cyclical self tests
- ▶ Potentially isolated PROFIBUS DP interface
- ▶ Infeed for module supply
 - Polarity protection
 - Voltage monitoring

- Transient voltage limitation
- 20 ms voltage buffer if the supply voltage is interrupted
- ▶ Module supply
 - Short circuit-proof
- ▶ Periphery supply
 - Voltage monitoring (exceeding upper/lower limit)

4.5 SD card

The SD card has the following functions:

- ▶ The SD card is used to store the naming data and the device project; see PSS 4000 System Description.
- ▶ The SD card is part of the safety concept on PSS 4000. If the SD card is missing or has been swapped, the next time the PSSu system is booted it will be unable to achieve the operating status "PSSu System in RUN condition without error". The SD card has a locking mechanism, which protects it from being removed from the card holder unintentionally. The SD card can also be sealed to protect it from manipulation, whether accidental or intentional.

Sealing the SD card for additional protection:

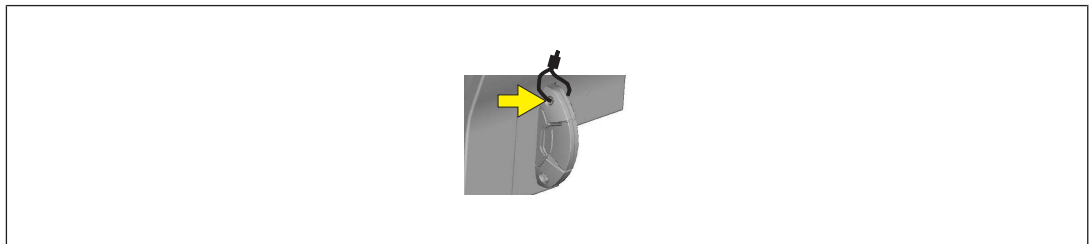

4.6 Reset button

The "Reset" button on the head module has various functions:

- ▶ Perform a warm reset for the PSSu system
The reset button can be used to perform a warm reset for the PSSu system.
- ▶ Transfer the naming data and/or device project from the SD card (deliberate operator action to transfer the naming data and/or device project from the SD card to the device memory).



INFORMATION

The warm reset and the transfer of the naming data and/or device project are described in the "PSS 4000 System Description". This is also where the general effects on the PSSu system are described in detail.

4.7 PROFIBUS DP

4.7.1 Connection to PROFIBUS DP

PROFIBUS is an open fieldbus standard whose communication is defined in the international standards IEC 61158 and IEC 61784. Further provisions have been defined in specifications published by the PROFIBUS User Group. These specifications are available from PROFIBUS International (see www.profibus.com).

4.7.2 Selector switch for setting the station address

The station address is set via the "ADDRESS" DIP switch. The DIP switch is binary coded. Permitted station addresses are in the range $0_D \dots 125_D$. If station address 126_D is set via the DIP switch, the address can be assigned via the Master. The Set Slave Address command (SSA) must be run for this purpose.

The station address is set as follows:

| "ADDRESS" DIP switch | Meaning | | Example: |
|----------------------|---------------|--------|---|
| Switch designation | OFF | ON | Station address PSSu: 26_D F-device: 52_D |
| -- | Not connected | |  |
| -- | | | |
| 64 | 0 | 64_D | |
| 32 | 0 | 32_D | |
| 16 | 0 | 16_D | |
| 8 | 0 | 8_D | |
| 4 | 0 | 4_D | |
| 2 | 0 | 2_D | |
| 1 | 0 | 1_D | |



INFORMATION

The station address should **only** be set when the module is switched off (no voltage applied).

The settings are **only** transferred when booting. Any changes made to the settings during operation will **not** be transferred.

4.8 Ethernet Interface

4.8.1 RJ45 interfaces ("Ethernet")

The Ethernet interface can be used for the following online actions:

- ▶ Download the project
- ▶ Read the diagnostic data

► Firmware update

The connection is established via a RJ45 socket.

The Ethernet interface is configured in PAS4000 (see description in chapter "Network" in PAS4000's online help).

4.8.2 RJ45 connection cable

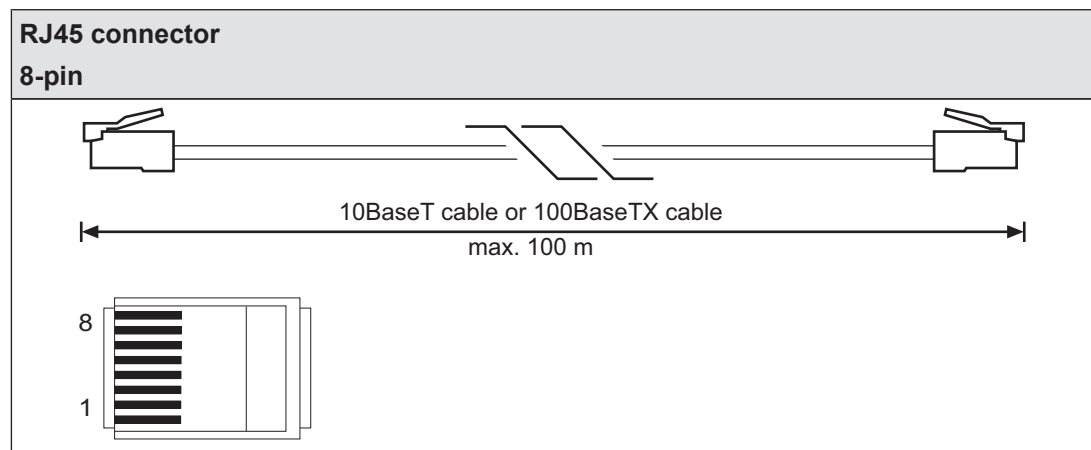

5 Installation

5.1 General installation guidelines

Please also refer to the PSSuniversal Installation Manual.

The description below assumes that the mounting rail is already installed.



NOTICE

Damage due to electrostatic discharge!

Electrostatic discharge can damage components. Ensure against discharge before touching the product, e.g. by touching an earthed, conductive surface or by wearing an earthed armband.

5.2 Dimensions

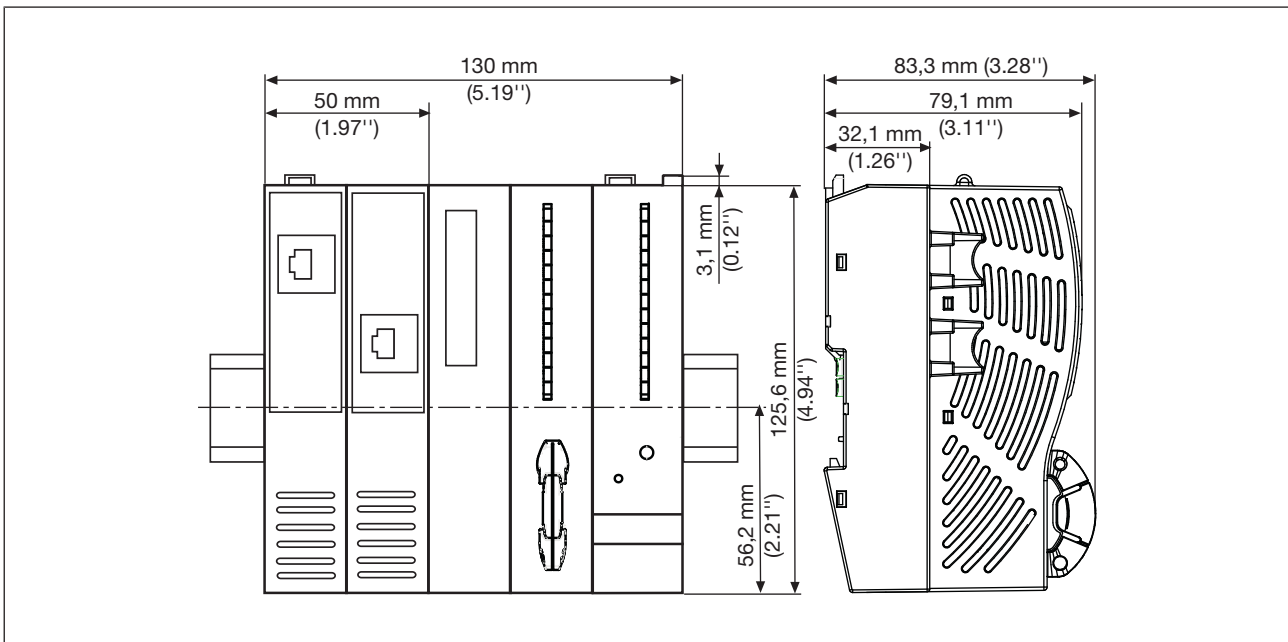

5.3 Installing the head module

Prerequisite:

- ▶ The mounting rail must be installed.

Please note:

- ▶ All contacts should be protected from contamination.

Procedure:

- ▶ Install an end bracket to the left of the head module or leave enough space for one.
- ▶ Slot the groove on the head module on to the mounting rail from below [1].
- ▶ Push the head module back as far as it will go [2].

- ▶ Make sure that the locking mechanisms [3] are pushed downwards, connecting the module firmly to the mounting rail.

Schematic representation:

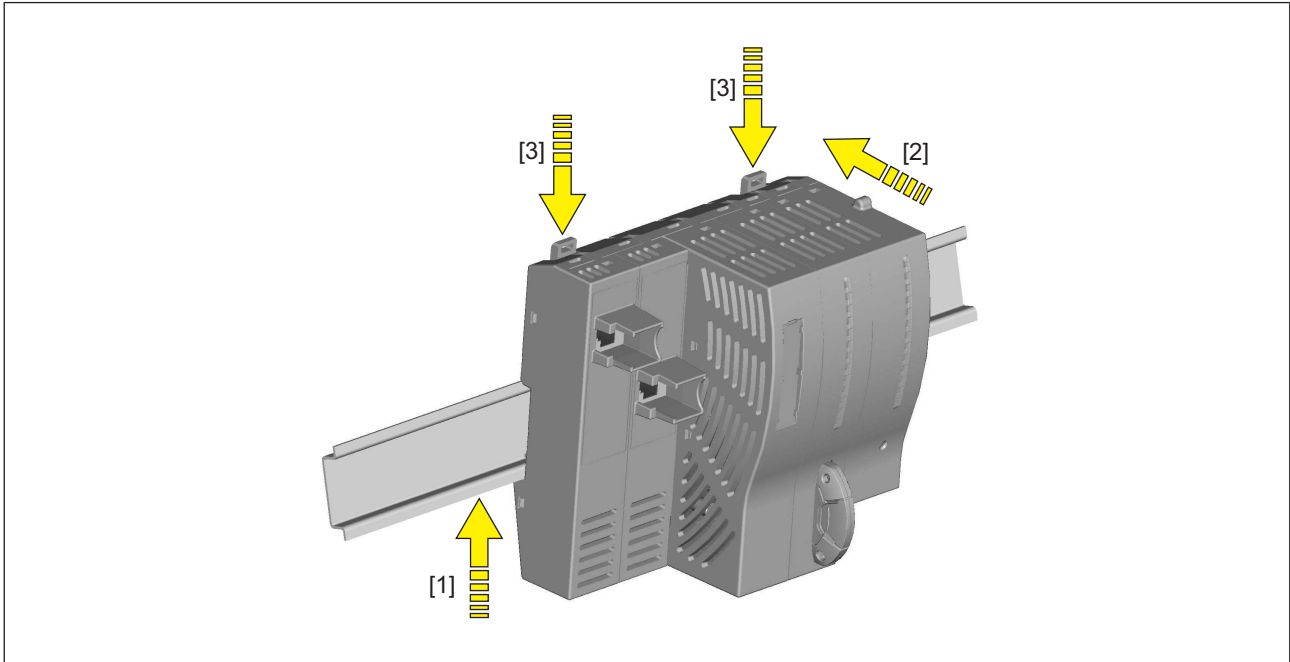

6 Interfaces

6.1 Interface configuration

6.1.1 PROFIBUS DP

The head module can be incorporated into the PROFIBUS as slave.

| PROFIBUS DP | Layout | |
|--|--|--|
| Female 9-pin D-SUB connector conforms to the guidelines of the PROFIBUS User Group (PNO) | 1: n.c. 2: n.c. 3: RxD/TxD-P (B-line) 4: CNTR-P (RTS) 5: DGND (GND ext.) 6: VP (+5 V ext.) 7: n.c. 8: RxD/TxD-N (A-line) 9: n.c. | |

▶ n.c. = not connected

The PSSu is connected to PROFIBUS-DP via RS 485 communication. The PSSu supplies the PROFIBUS DP bus terminating resistors with voltage (+5 VDC).



INFORMATION

The two data lines are also called A and B on PROFIBUS.

Always connect the A-line ("RxD/TxD-N") to the A-lines of all the other PROFIBUS subscribers.

The B-line ("RxD/TxD-P") should only be connected to the B-lines of the other PROFIBUS subscribers.

If communication is not established, check the connections using a continuity tester.

▶ Connect the connector housing to the shielding on the PROFIBUS cable. The connector housing should be connected with low impedance to the mounting rail.



CAUTION!

Do not use the signals VP (+5 V ext.) and DGND (GND ext.) to supply voltage to external devices! They are exclusively used to supply the PROFIBUS DP bus terminating resistors.

6.1.2 Ethernet

Ethernet Interface

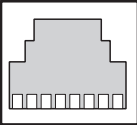
| RJ45 socket 8-pin | PIN | Standard | Crossover |
|---|-----|-----------------|-----------------|
|  <p data-bbox="499 483 619 510">8 1</p> | 1 | TD+ (Transmit+) | RD+ (Receive+) |
| | 2 | TD- (Transmit-) | RD- (Receive-) |
| | 3 | RD+ (Receive+) | TD+ (Transmit+) |
| | 4 | n.c. | n.c. |
| | 5 | n.c. | n.c. |
| | 6 | RD- (Receive-) | TD- (Transmit-) |
| | 7 | n.c. | n.c. |
| | 8 | n.c. | n.c. |

7 Wiring

7.1 General wiring guidelines

Please note:

- ▶ The requirements of the supply voltages can be found in the chapter entitled "Technical Details".
- ▶ Protective separation must be ensured for the external power supplies that generate the supply voltages. Failure to do so could result in electric shock.
- ▶ The external power supplies must comply with the current applicable standard EN 60950-1, EN 61140, EN 50178 or EN 61558-1.
- ▶ The maximum current load for the periphery supply on the module bus is 10 A. Please refer to the derating diagram in the chapter entitled "Function Description".
- ▶ Earth the 0 V supply on the periphery supply or monitor each supply group for earth faults.
- ▶ The connection of the 0 V supply to the central earth bar or earth fault monitor must be in accordance with relevant national regulations (e.g. EN 60204-1, NFPA 79:17-7, NEC: Article 250).
- ▶ Details of the minimum range for conductor cross sections on connection terminals can be found in the section entitled "Technical Details".
- ▶ Use copper wiring.

7.2 Terminal configuration

| Module supply | Terminal configuration | | X1 |
|------------------------|------------------------|--------------------------------|----|
| 4-pin female connector | 24V | +24 V infeed for module supply | |
| | 0V | 0 V infeed for module supply | |

| Periphery supply | Terminal configuration | | X2 |
|------------------------|------------------------|-----------------------------------|----|
| 4-pin female connector | 24V: | +24 V infeed for periphery supply | |
| | 0V | 0 V infeed for periphery supply | |
| | | Functional earth | |

7.3 Connecting the module

Separate power supplies for module supply and periphery supply:

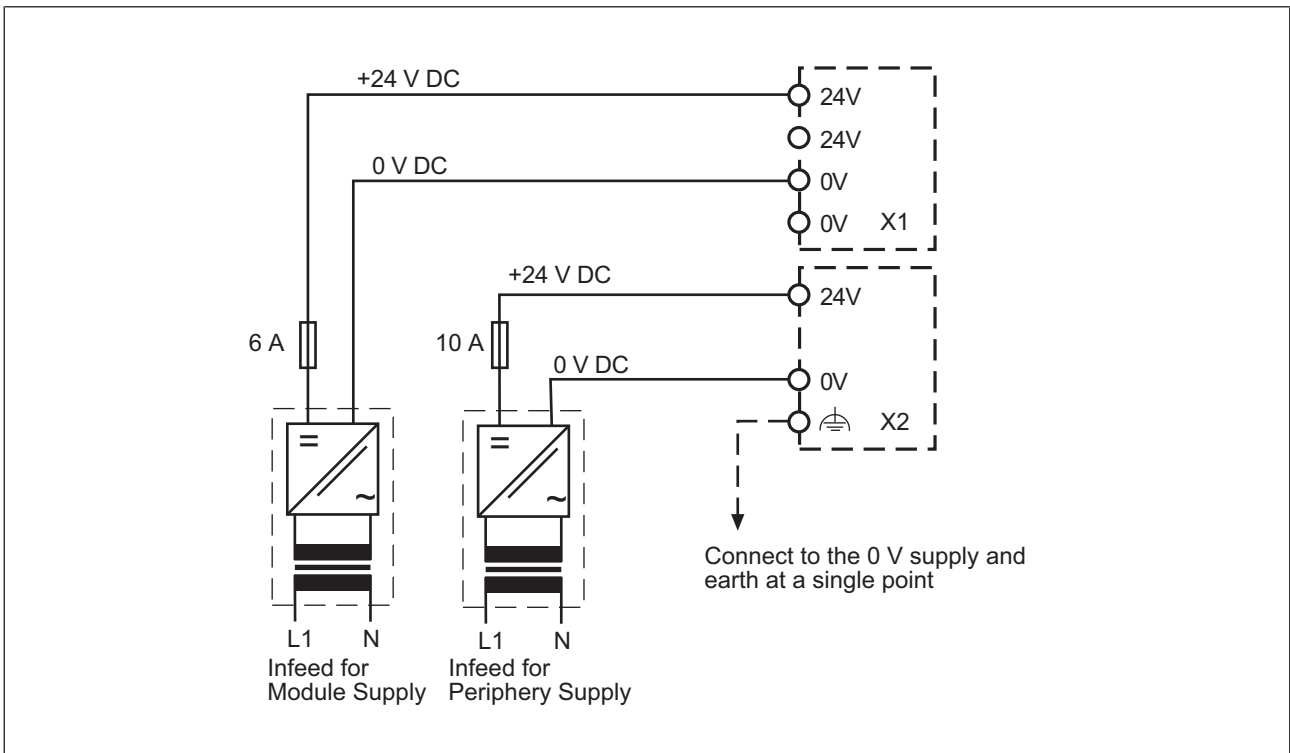

Common power supply for module supply and periphery supply:

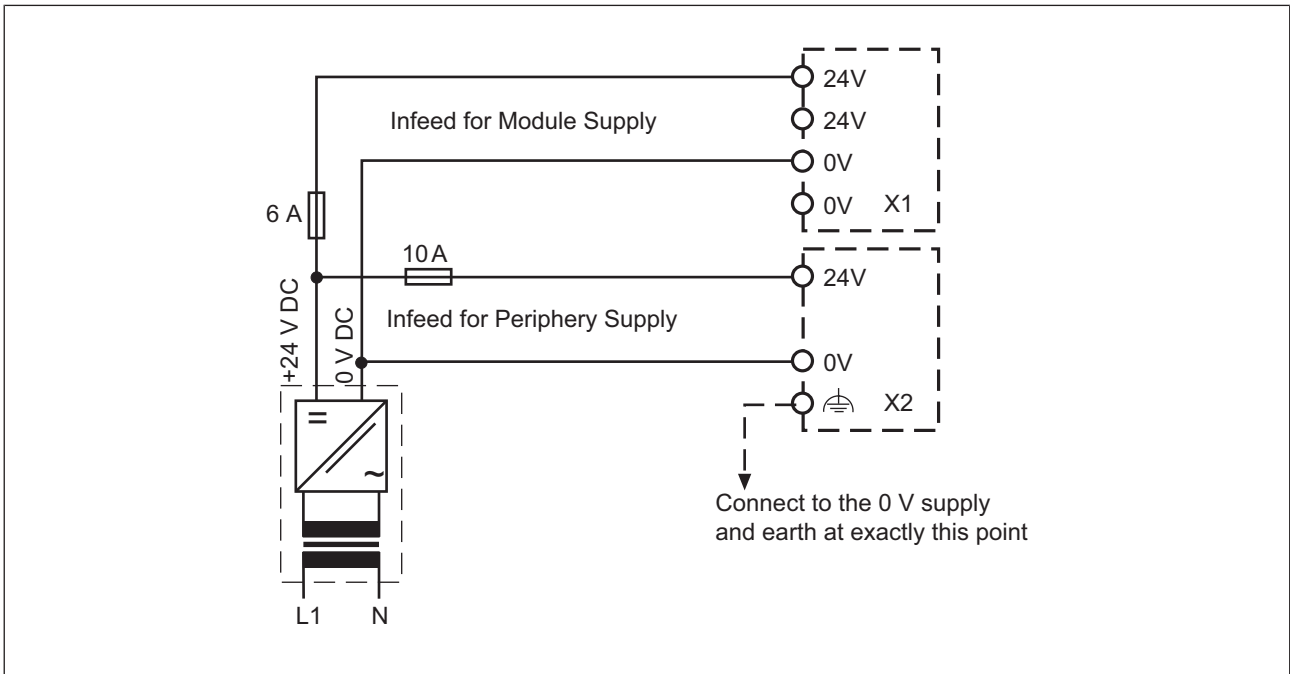

8 Operation

8.1 Messages

The PSSu system provides many options for diagnostics, fault detection and communication with other control systems.

Diagnostics for the PSSu system can be run via the

- ▶ LEDs on the head module,
- ▶ Diagnostic table and diagnostic log.

All errors and faults detected by the electronic or compact modules in a PSSu system are signalled to the head module and entered in the diagnostic table and diagnostic log. You can read the head module's diagnostic table and diagnostic log, e.g. using the PAS4000 or the combination of OPC Server and PSS 4000 Diag Control.

8.2 Display elements

The head module contains a number of status LEDs, which provide information on the status of various system sections.

LEDs on the PSSu H m F DP ETH SD:

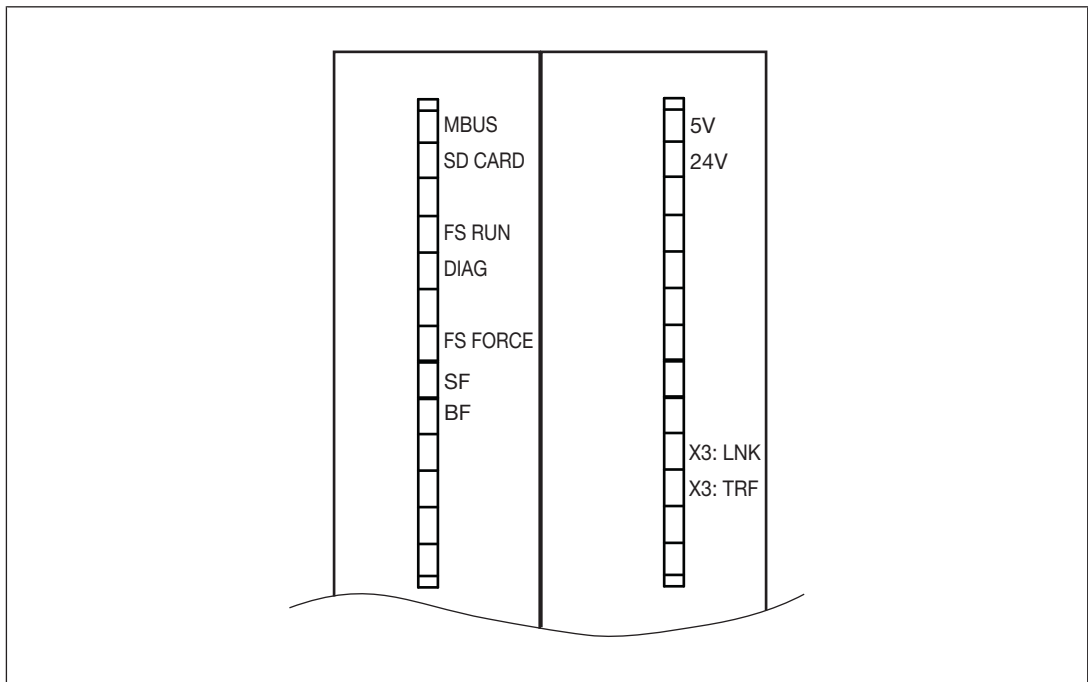





Legend:

| | |
|--|-------------|
| | LED on |
| | LED flashes |
| | LED off |







8.2.1 MBUS

The "MBUS" LED indicates the status of the FS and ST module bus.

| Colour | Status | Meaning |
|--------|---|--|
| - - - |  | No modules present |
| Green |  | FS and ST module bus are operating without fault |
| Red |  | Operating state "Safe condition of all FS outputs on the PSSu system" or Unable to locate at least one module (e.g. a module has been removed during operation, actual/ registered hardware does not match) |
| |  | Operating state "FS module bus in a STOP condition with error: Major FS error" |

8.2.2 SD CARD

The "SD CARD" LED shows the status of the removable data medium.

| Colour | Status | Meaning |
|-----------|---|--|
| - - - |  | Supply voltage for module supply is missing |
| Red |  | SD card is missing or SD card not recognised or SD card defective |
| Green |  | Naming data and device project on the PSSu system and SD card match |
| |  | Product type on the SD card does not match the head module or No device project on the SD card |
| Green-red |  | Naming data and device project on the PSSu system and SD card do not match |
| Orange |  | Device identification activated by user |

8.2.3 FS RUN







The "FS RUN" LED shows the status of the FS resource.

| Colour | Status | Meaning |
|--------|--------|---|
| - - - | | FS resource has not been started or is in a STOP condition |
| Green | | Operating state "FS resource in RUN condition without error": The FS resource tasks are running without error. The project is licensed. |
| | | Operating state: "FS resource in RUN condition with error": - Task in TERMINATED condition or - Task in STOP condition At least one FS resource task is not running. The project is licensed. |
| Orange | | Operating state "FS resource in RUN condition without error": The FS resource tasks are running without error. The project is unlicensed. |
| | | Operating state: "FS resource in RUN condition with error": - Task in TERMINATED condition or - Task in STOP condition At least one FS resource task is not running. The project is unlicensed. |

- ▶ Only one task is present on the FS resource.

8.2.4 DIAG

The "DIAG" LED indicates whether there is a fault on a system section of the PSSu system. Precise evaluation can be made via the diagnostic list.

| Colour | Status | Meaning |
|-------------|---|---|
| - - - | ● | No system section is started, module supply is missing. |
| Green |  | No message of "Error" or "Warning" severity is present for the device. |
| |  | Device diagnostic list and device diagnostic log are being prepared |
| Red |  | A message of "Error" severity is present for at least one system section (see diagnostic list). |
| |  | A major FS error is present for at least one FS system section (see diagnostic list). |
| Orange |  | A message of at least "Warning" severity is present for the PSSu system (see diagnostic list). |
| Red - green |  | Start of "deliberate operator action" (function of reset button) |

8.2.5 FS FORCE

The "FS FORCE" LED shows the status of forcing on the FS resource.

| Colour | Status | Meaning |
|--------|--------|--|
| - - - | ● | Forcing on the FS resource is inactive |
| Yellow | ☀ | Forcing on the FS resource is active |

8.2.6 SF, BF

The LEDs "SF" and "BF" show errors in the bus connection of errors by a subscriber in in the bus.

| Colour SF | Colour BF | State SF | State BF | Key |
|-----------|-----------|----------|----------|--------------------------------------|
| --- | --- | ● | ● | Supply voltage is missing |
| --- | Red | ● | ☀ | No connection to the bus subscribers |
| --- | Red | ● | ◐ | Configuration faulty |
| Red | --- | ☀ | ● | Error in the head module |
| --- | Green | ● | ☀ | Data transmission error-free |

8.2.7 5V, 24V

The "5 V" LED shows the status of the module supply.

| Colour | Status | Meaning |
|--------|--------|---|
| --- | ● | No supply voltage for module supply or supply voltage is faulty |
| Green | ☀ | Module supply is available on the module bus |



The "24 V" LED shows the status of the periphery supply.

| Colour | Status | Meaning |
|--------|--------|--|
| --- | ● | No supply voltage for periphery supply or supply voltage is faulty |
| Green | ☀ | Periphery supply is available on the module bus |



8.2.8 X3: LNK, X3: TRF

These status LEDs are the display elements for the Ethernet/SafetyNET p interfaces. The interface is assigned two LEDs at the head module. Various operating and fault statuses on the Ethernet/SafetyNET p interface are displayed via the LEDs.

X3: LNK

| Colour | State | Key |
|--------|---|----------------------------------|
| --- |  | No network connection |
| Green |  | Network connection is error-free |

X3: TRF

| Colour | State | Key |
|--------|---|----------------------------|
| --- |  | No data traffic |
| yellow |  | Data traffic is error-free |

9 Technical details

| General | |
|---|--|
| Approvals | BG, CE, EAC (Eurasian), GOST, TÜV, cULus Listed |
| Application range | Standard/failsafe |
| System sections | |
| ST resource | No |
| FS resource | Yes |
| ST module bus | Yes |
| FS module bus | Yes |
| ST SNp interface | No |
| FS SNp interface | No |
| PROFIBUS-DP Slave | Yes |
| IP Connections | |
| IP Connections | Yes |
| PROFIBUS DP | Yes |
| Diagnostic Server | No |
| OPC Server | No |
| Programming | |
| IEC 61131 programming | No |
| Multi programming | Yes |
| Non-volatile variables | No |
| Electrical data | |
| Supply voltage | |
| for | Module supply |
| Voltage | 24,0 V |
| Kind | DC |
| Voltage tolerance | -30 %/+25 % |
| Max. continuous current that the external power supply must provide | 1,0 A |
| Output of external power supply (DC) | 16,1 W |
| Supply voltage | |
| for | Periphery supply |
| Voltage | 24 V |
| Kind | DC |
| Voltage tolerance | -30 %/+25 % |
| Max. continuous current that the external power supply must provide | 10,0 A |
| Potential isolation between module supply and periphery supply | 3050 V |
| Potential isolation between Module Supply and PROFIBUS DP | 700 V |

| Electrical data | |
|--|--|
| Internal supply voltage (module supply) | |
| Output voltage | int. system |
| Voltage | 5 V |
| Voltage tolerance | -2 %/+3 % |
| Potential isolation | 3050 V |
| Current load capacity | 2,0 A |
| Buffer in the case of supply interruptions in accordance with | EN 61131-2, EN 61496-1 |
| Short circuit-proof | Yes |
| CPU | |
| Real-time clock for time and date, buffered | |
| Resolution | 1 s |
| Deviation | +/- 10s/Day |
| Buffer time | 10 days |
| Max. number of FS tasks | 1 |
| Max. number of variables with elementary data types on the FS resource | 10.000 |
| Min. cycle time, FS tasks | 10 ms |
| Working memory (RAM) | 64 MB |
| Memory for the user program per resource | 2 MB |
| Removable data medium | |
| Type | SD card |
| External communication | |
| Max. number of IP connections | 32 |
| Modbus/TCP | |
| Cycle time (t _{ExtCo}) | 2...2 000 000 ms |
| Raw UDP | |
| Cycle time (t _{ExtCo}) | 2...2 000 000 ms |
| SafetyNET p interface | |
| Number | 1 |
| IP address (automatically off) | 169.254.X.Y |
| Connection | RJ45 |
| Transmission rates | 100 MBit/s |
| Set via | automatic |
| PROFIBUS DP interface | |
| Number | 1 |
| Unit type | Slave |
| Station address | 0 ... 126d |
| Station address selectable via | DIP-Schalter |
| Maximum data length of the Profibus interface | |
| Input | 244 Byte |
| Output | 244 Byte |
| Diagnostics | 2 Byte |
| Transmission rates | 1,5 MBit/s, 12 MBit/s, 185,5 kBit/s, 19,2 kBit/s, 3 MBit/s, 45,45 kBit/s, 500 kBit/s, 6 MBit/s, 9,6 kBit/s, 93,75 kBit/s |

| PROFIBUS DP interface | |
|---------------------------------------|---|
| Transmission rate selectable via | automatisch |
| Connection | 9-pin female D-Sub connector |
| Protocol | DPV0 |
| Operating modes | AutoBaud, Freeze Mode, Set Slave Address, Sync Mode |
| Certification | PNO |
| Description file | Pilz0CB0.gsd |
| Manufacturer's ID | 0CB0h |
| Cycle time (t_ExtCo) | 2...300 000 ms |
| Ethernet interface | |
| Number | 1 |
| IP address (automatically off) | 169.254.X.Y |
| Connection type | RJ45 |
| Transmission rate | 100 MBit/s |
| Environmental data | |
| Climatic suitability | EN 60068-2-1, EN 60068-2-14, EN 60068-2-2, EN 60068-2-30, EN 60068-2-78 |
| Ambient temperature | |
| Temperature range | 0 - 60 °C |
| Storage temperature | |
| Temperature range | -25 - 70 °C |
| Climatic suitability | |
| In accordance with the standard | EN 60068-2-78 |
| Humidity | 93 % r. h. at 40 °C |
| Condensation during operation | Not permitted |
| EMC | EN 61000-4-2, EN 61000-4-3, EN 61000-4-4, EN 61000-4-5, EN 61000-4-6, EN 61000-6-2, EN 61000-6-4 |
| Vibration | |
| In accordance with the standard | EN 60068-2-6 |
| Frequency | 10,0 - 55,0 Hz |
| Amplitude | 0,35 mm |
| Acceleration | 1g |
| Shock stress | |
| In accordance with the standard | EN 60068-2-27 |
| Number of shocks | 6 |
| Acceleration | 15g |
| Duration | 11 ms |
| In accordance with the standard | EN 60068-2-27 |
| Number of shocks | 1000 |
| Acceleration | 10g |
| Duration | 16 ms |
| Max. operating height above sea level | 2000 m |

| Environmental data | |
|---|--|
| Airgap creepage | |
| In accordance with the standard | EN 60664-1 |
| Overvoltage category | II |
| Pollution degree | 2 |
| Protection type | |
| Mounting area (e.g. control cabinet) | IP54 |
| Housing | IP20 |
| Mechanical data | |
| Material | |
| Bottom | PC |
| Connection type | Spring-loaded terminal, screw terminal |
| Mounting type | plug-in |
| Conductor cross section with screw terminals | |
| 1 core flexible | 0,25 - 2,50 mm², 24 - 12 AWG |
| 2 core with the same cross section, flexible with crimp connectors, no plastic sleeve | 0,25 - 1,00 mm², 24 - 16 AWG |
| 2 core with the same cross section, flexible without crimp connectors or with TWIN crimp connectors | 0,20 - 1,50 mm², 24 - 16 AWG |
| Torque setting with screw terminals | 0,50 Nm |
| Conductor cross section with spring-loaded terminals: | |
| Flexible with/without crimp connector | 0,20 - 2,50 mm², 24 - 12 AWG |
| Stripping length with spring-loaded terminals | 9,0 mm |
| Dimensions | |
| Height | 125,6 mm |
| Width | 130,0 mm |
| Depth | 83,7 mm |
| Weight | 405 g |

Where standards are undated, the 2009-07 latest editions shall apply.

9.1 Safety characteristic data

| Operating mode | EN ISO 13849-1: 2008 | EN ISO 13849-1: 2008 | EN 62061 | EN 62061 | IEC 61511 | IEC 61511 | EN ISO 13849-1: 2008 |
|----------------|----------------------|----------------------|----------|------------------------|-----------|-----------|-----------------------|
| | PL | Category | SIL CL | PFH _D [1/h] | SIL | PFD | T _M [year] |
| – | PL e | Cat. 4 | SIL CL 3 | 4,14E-09 | SIL 3 | 3,51E-05 | 20 |

10 Order reference

10.1 Product

| Product type | Features | Order no. |
|----------------------|---|-----------|
| PSSu H m F DP ETH SD | Head module with PROFIBUS DP and an Ethernet interface, base type | 312 060 |

10.2 Accessories

Terminals

| Product type | Features | Order no. |
|------------------|-----------------------------|-----------|
| PSSu A Con 1/4 S | 2 x screw terminals | 313 110 |
| PSSu A Con 2/8 C | 2 x spring-loaded terminals | 313 111 |

► Support

Technical support is available from Pilz round the clock.

Americas

Brazil
+55 11 97569-2804
Canada
+1 888-315-PILZ (315-7459)
Mexico
+52 55 5572 1300
USA (toll-free)
+1 877-PILZUSA (745-9872)

Asia

China
+86 21 60880878-216
Japan
+81 45 471-2281
South Korea
+82 31 450 0680

Australia

+61 3 95446300

Europe

Austria
+43 1 7986263-0
Belgium, Luxembourg
+32 9 3217575
France
+33 3 88104000
Germany
+49 711 3409-444
Ireland
+353 21 4804983
Italy
+39 0362 1826711

Scandinavia

+45 74436332

Spain

+34 938497433

Switzerland

+41 62 88979-30

The Netherlands

+31 347 320477

Turkey

+90 216 5775552

United Kingdom

+44 1536 462203

You can reach our international hotline on:

+49 711 3409-444
support@pilz.com

Pilz develops environmentally-friendly products using ecological materials and energy-saving technologies. Offices and production facilities are ecologically designed, environmentally-aware and energy-saving. So Pilz offers sustainability, plus the security of using energy-efficient products and environmentally-friendly solutions.

Energy saving by Pilz



The 4-fold safety of automation

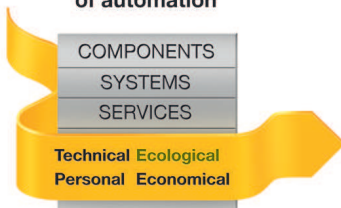

Pilz GmbH & Co. KG
Felix-Wankel-Straße 2
73760 Ostfildern, Germany
Tel.: +49 711 3409-0
Fax: +49 711 3409-133
info@pilz.com
www.pilz.com

pilz
the spirit of safety

CMSE, InduraNET p, PAS4000, PAScal, PASconfig, Pilz, PIT, PLID, PMCPrimo, PMCProtego, PMCTendo, PMD, PMI, PNOZ, Primo, PSEN, PSS, PVS, Safety SafetyYE, SafetyNET p, the spirit of safety, are registered and protected trademarks of Pilz GmbH & Co. KG in some countries. We would point out that product features may vary from the details stated in this document, depending on the status at the time of publication and the scope of the equipment. We accept no responsibility for the validity, accuracy and entirety of the text and graphics presented in this information. Please contact our Technical Support if you have any questions.